

January Furniture Show

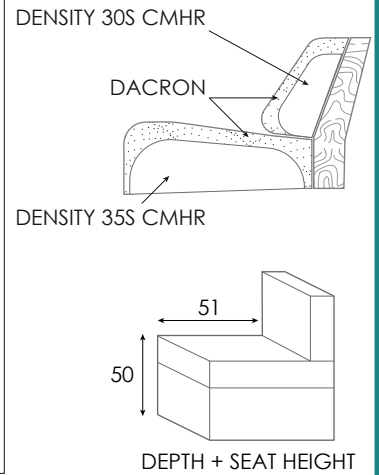

Model 5080 SEVILLE

Carcass: spruce, chipboard and multilayer panels.

Springing: polypropylene and natural elastic belts on back and rings on seats.

Padding: stress-resistant polyurethane foam available in different densities.

Seat cushions: stress-resistant polyurethane density 35S CMHR covered with Dacron hollow soft polyester fibre.

Back cushions: stress-resistant polyurethane density 30S CMHR covered with Dacron hollow soft polyester fibre.

Arms: stress-resistant polyurethane density 30S CMHR covered with Dacron hollow soft polyester fibre.

Feet: h 18 cm, Chrome or Titanium.

SEAT WIDTH: 84 CM

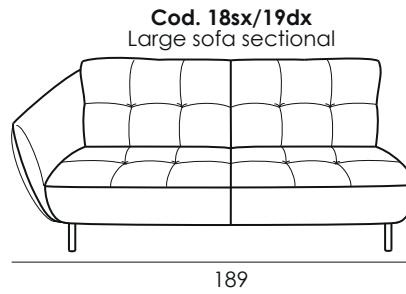
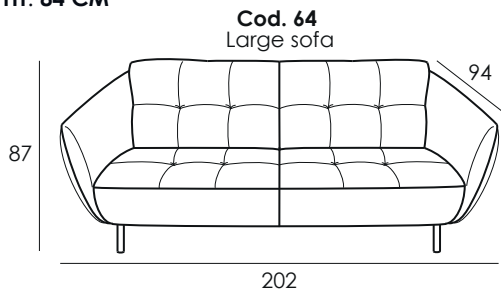

SEAT WIDTH: 74 CM

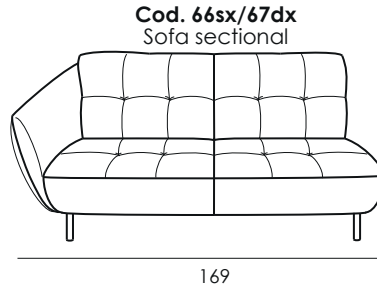
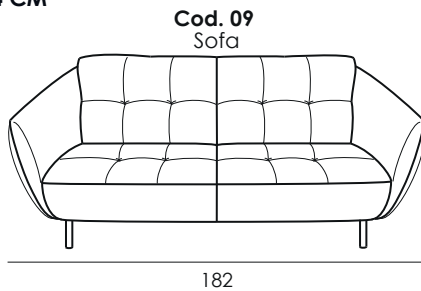

SEAT WIDTH: 64 CM

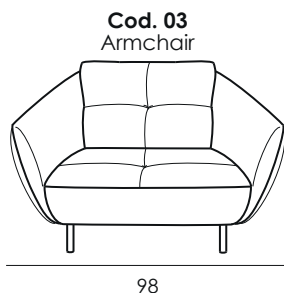
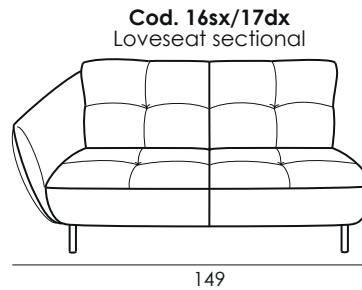
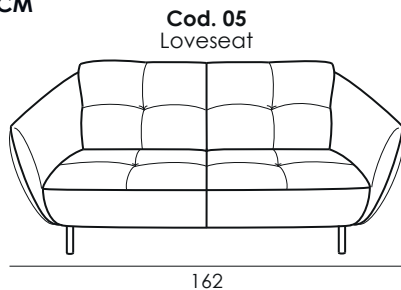

Cod. 234sx/235dx
Corner and armchair sectional

